

# *LED Brick Installing & Controlling*

By Shone Lighting

Step 1: Get all accessories ready

**Recessed Box**



**Power Supply**



**LED Brick**

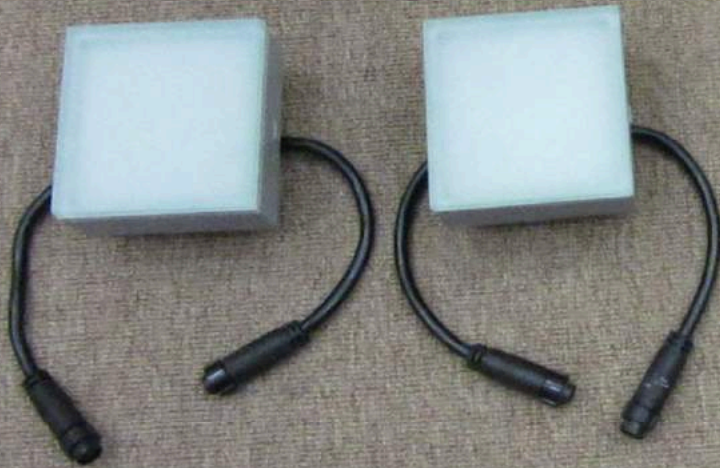

**DMX512 Controller**



**Terminals**



**Connecting Cable**



**Screwdriver**



Step 2: Take off the metal plate of the recessed box





**Metal Plate**

Step 3: Fix the recessed box

### Embedded Well

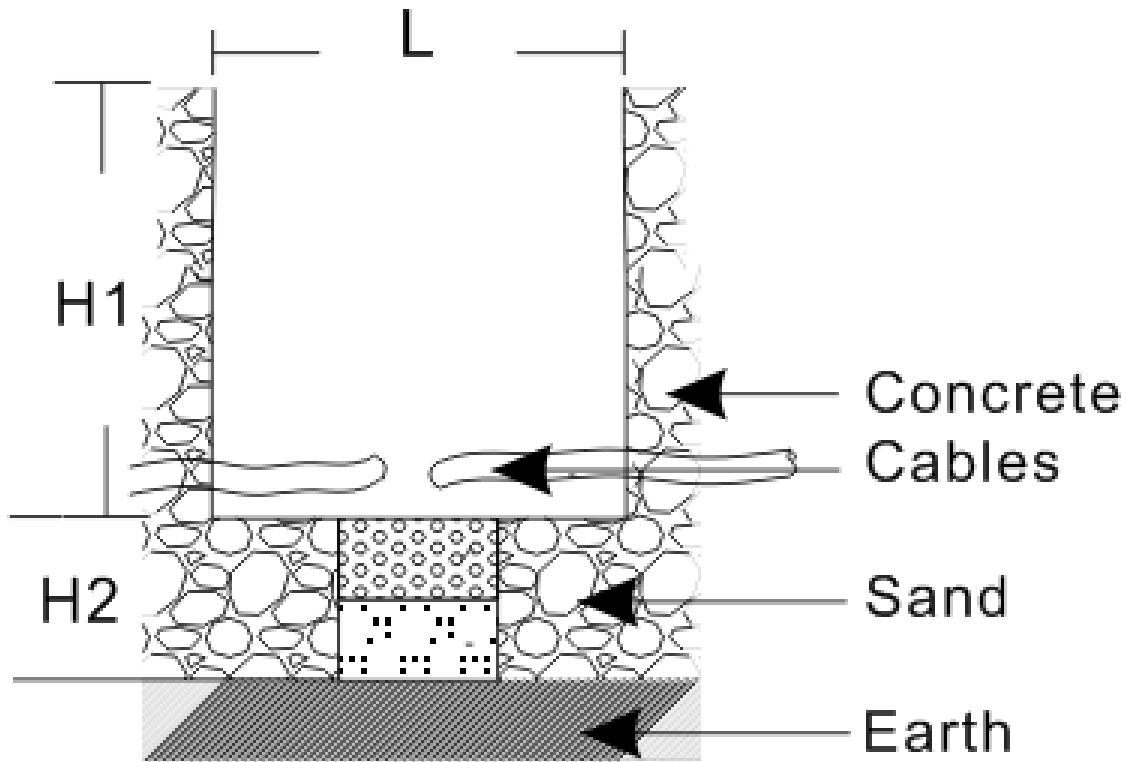

Dig an embedded well and prepare cables

### Recessed Box

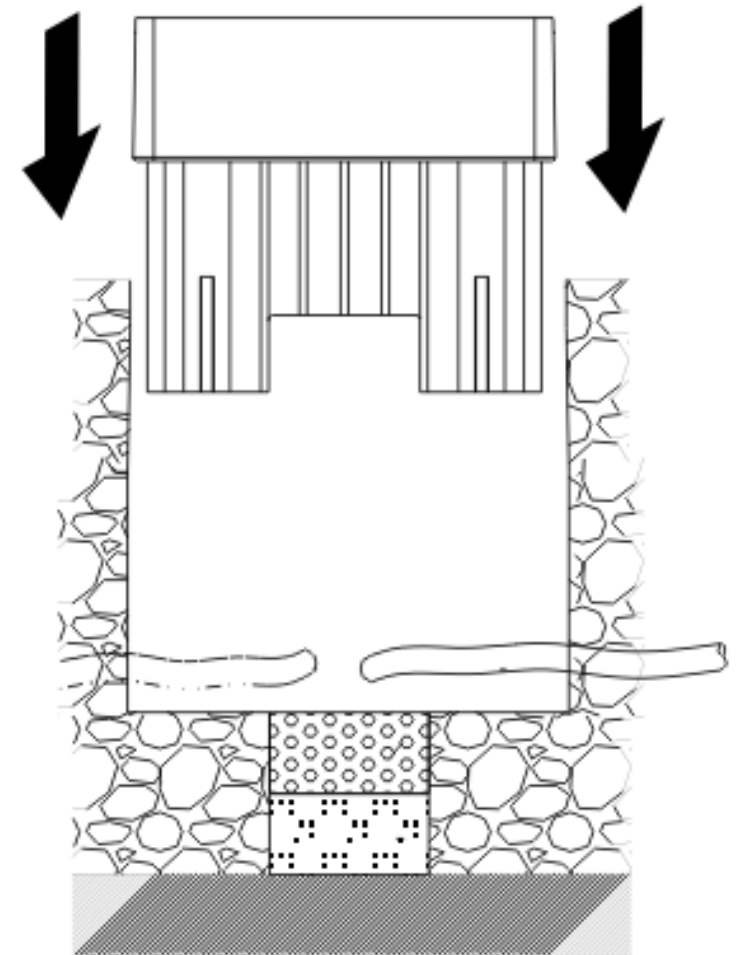

Put the recessed box into the embedded well

Step 4: Put the LED brick into the recessed box



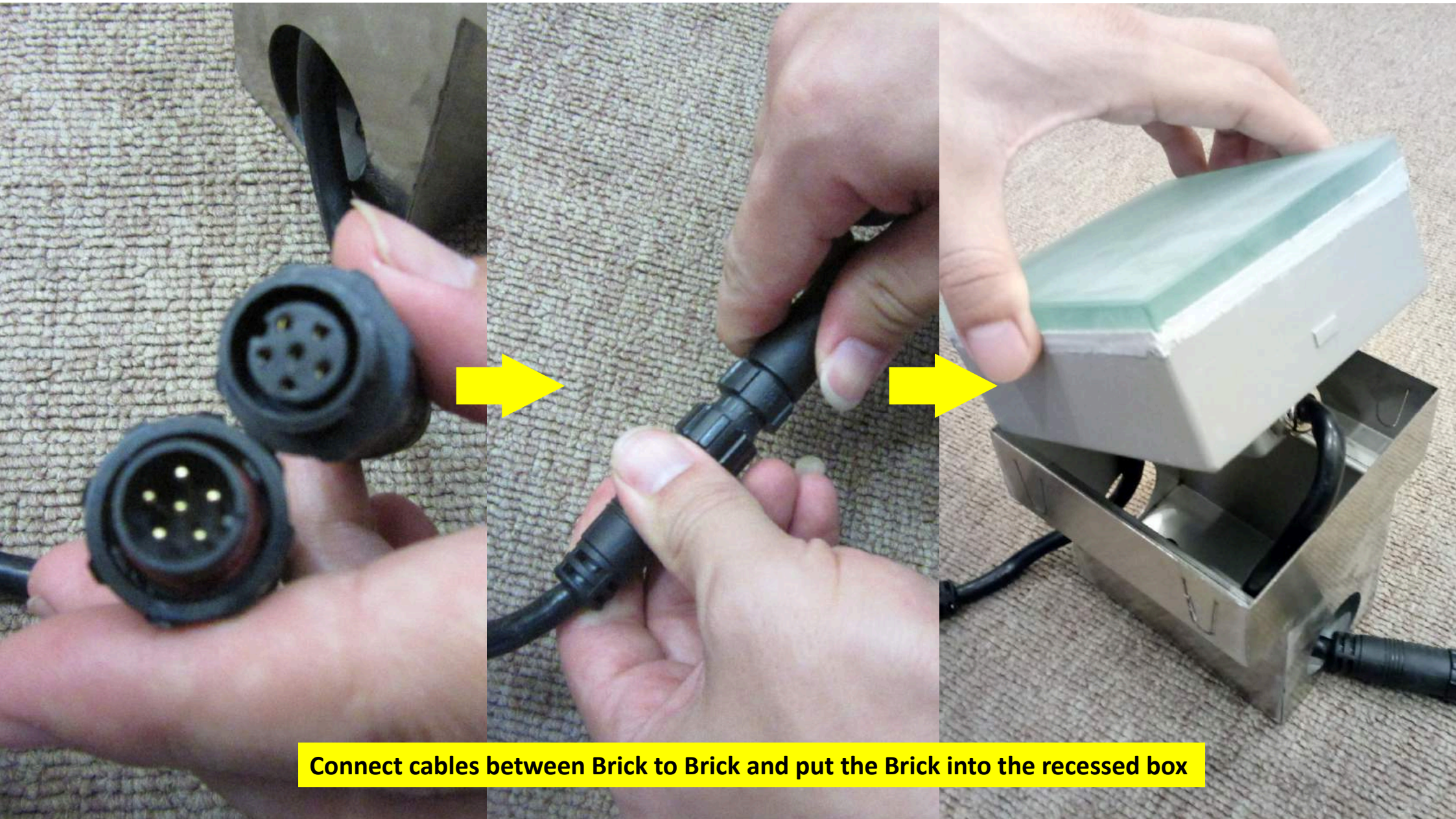

**Connect cables between Brick to Brick and put the Brick into the recessed box**

Step 5: Connect a free end cable to the first LED brick



**First LED Brick**

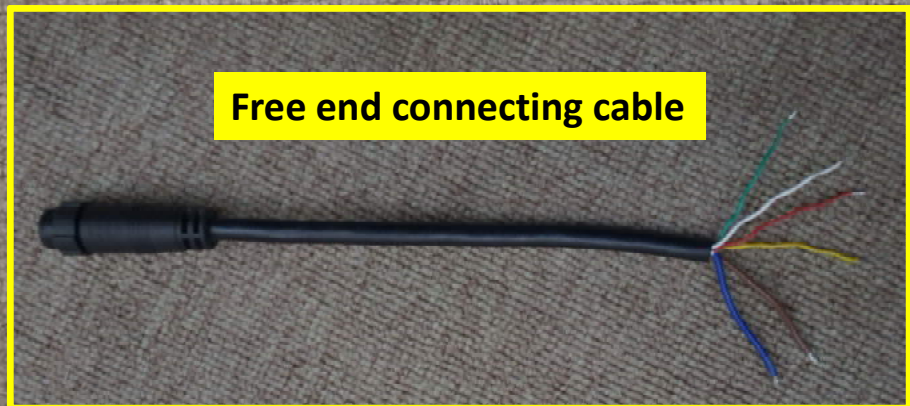

**Free end connecting cable**

Step 6: Connect signal cable to the controller



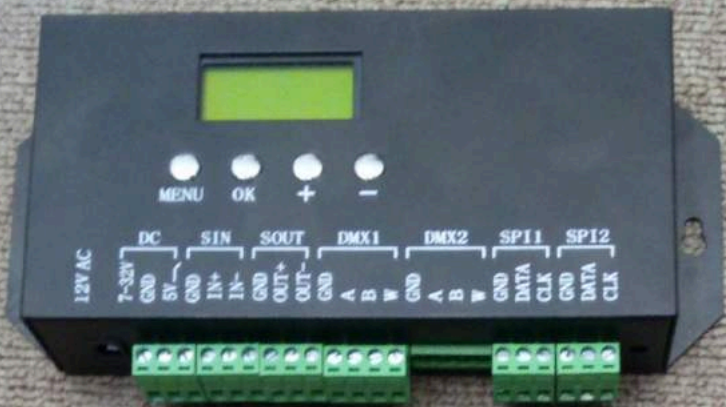

Yellow cable -- GND

Red cable -- A

White cable -- B

Green cable -- W

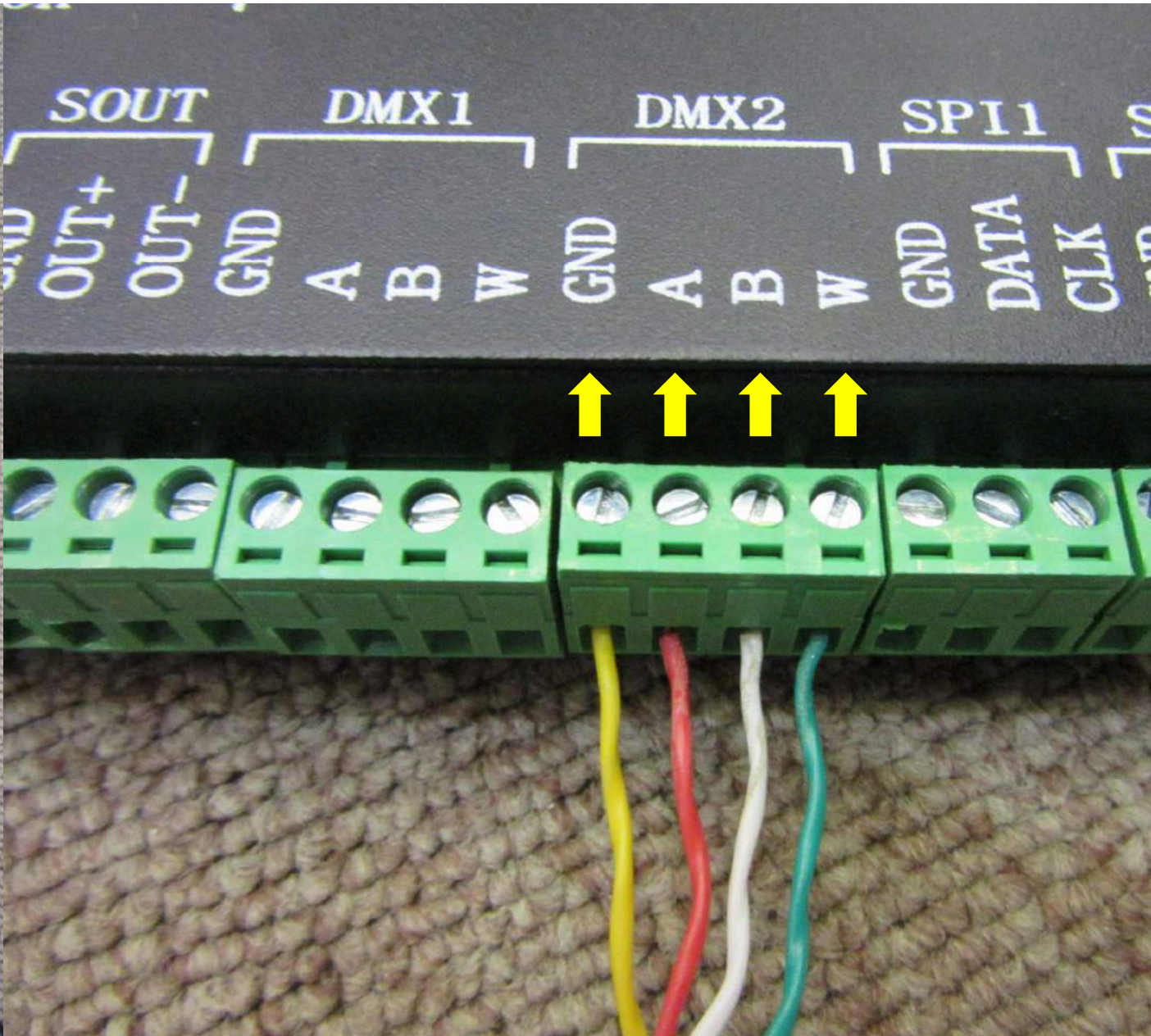

Step 7: Connect power cable to the power supply



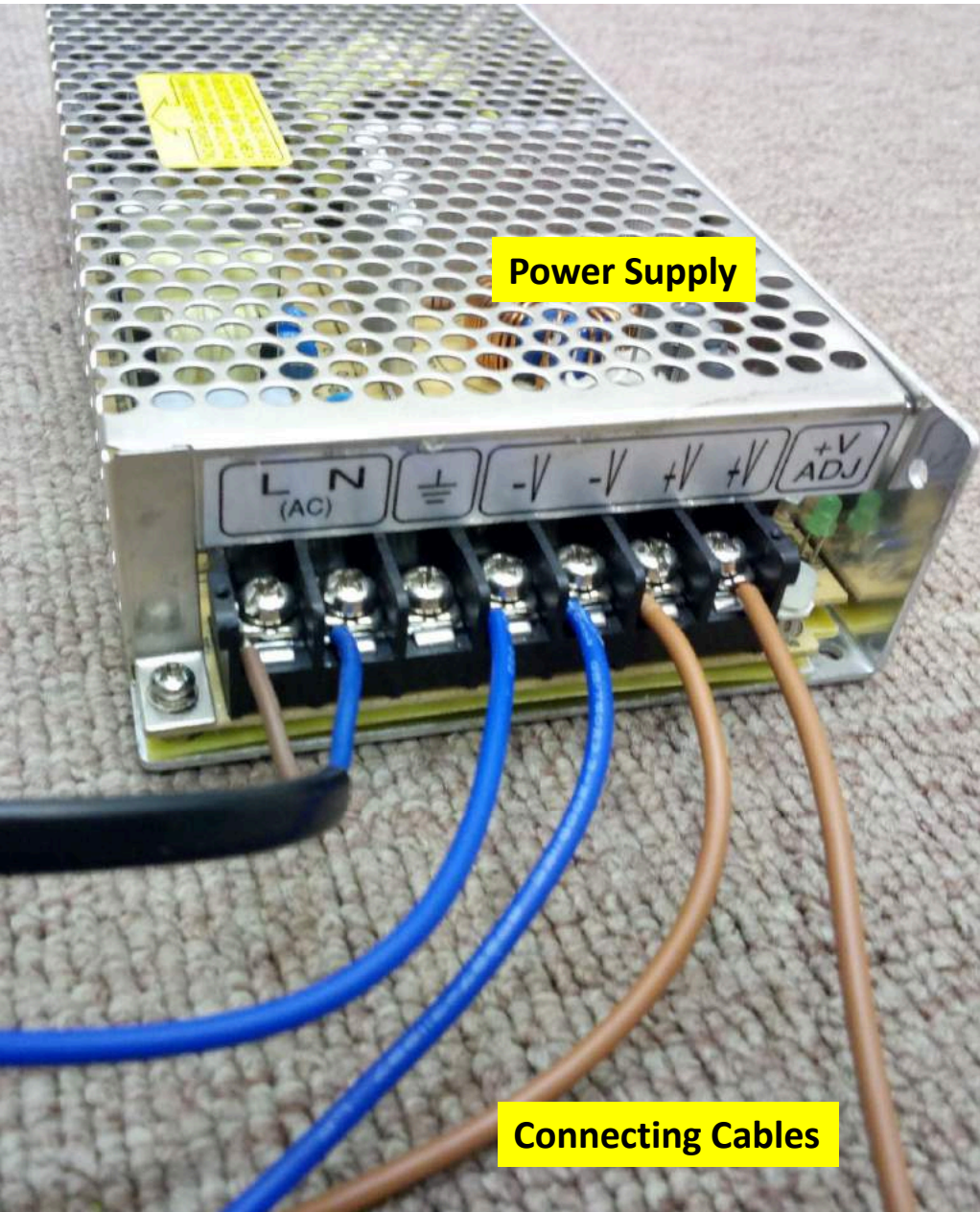

Power Supply

Connecting Cables

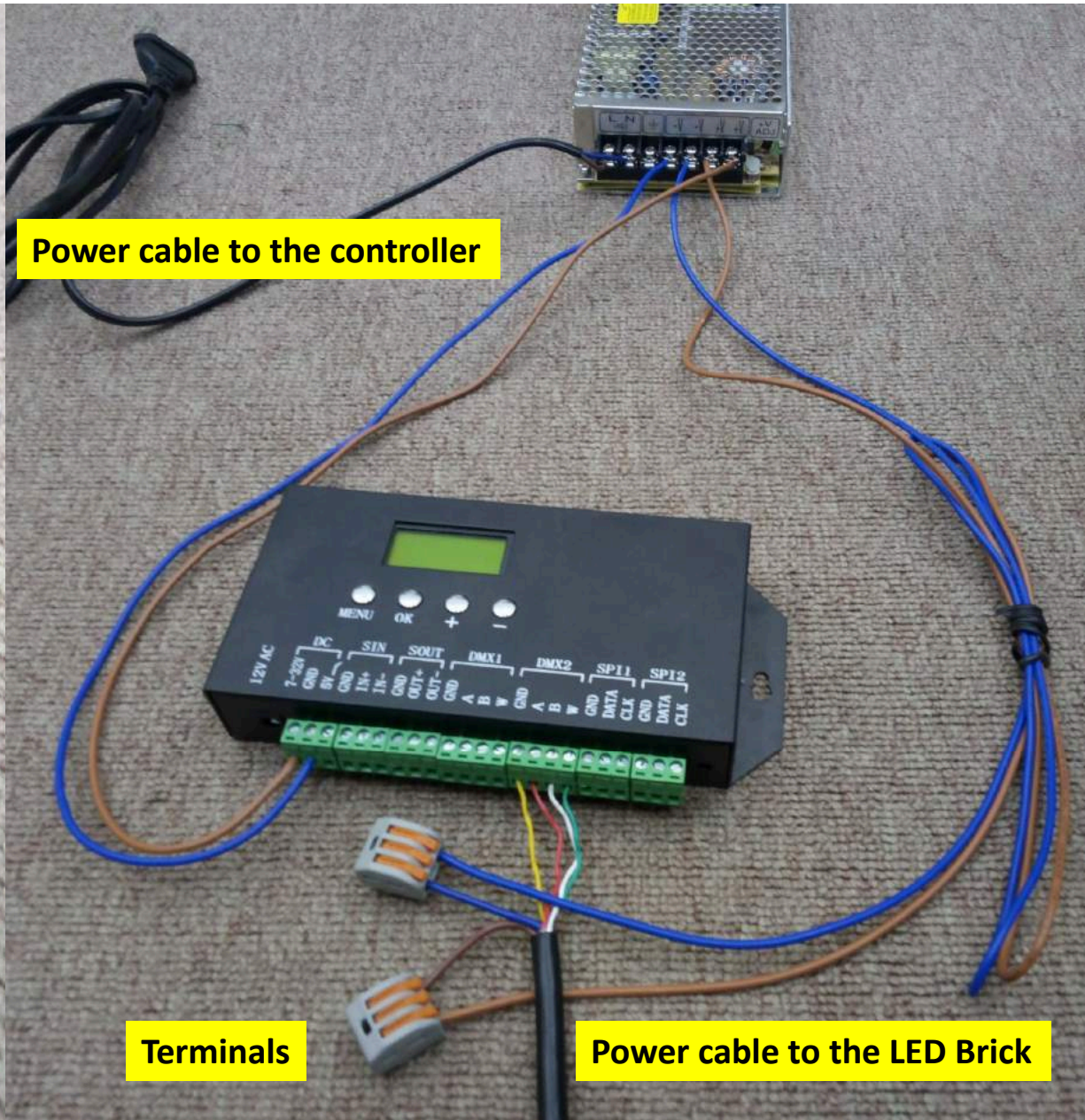

Power cable to the controller

Terminals

Power cable to the LED Brick

Step 8: Check all connection



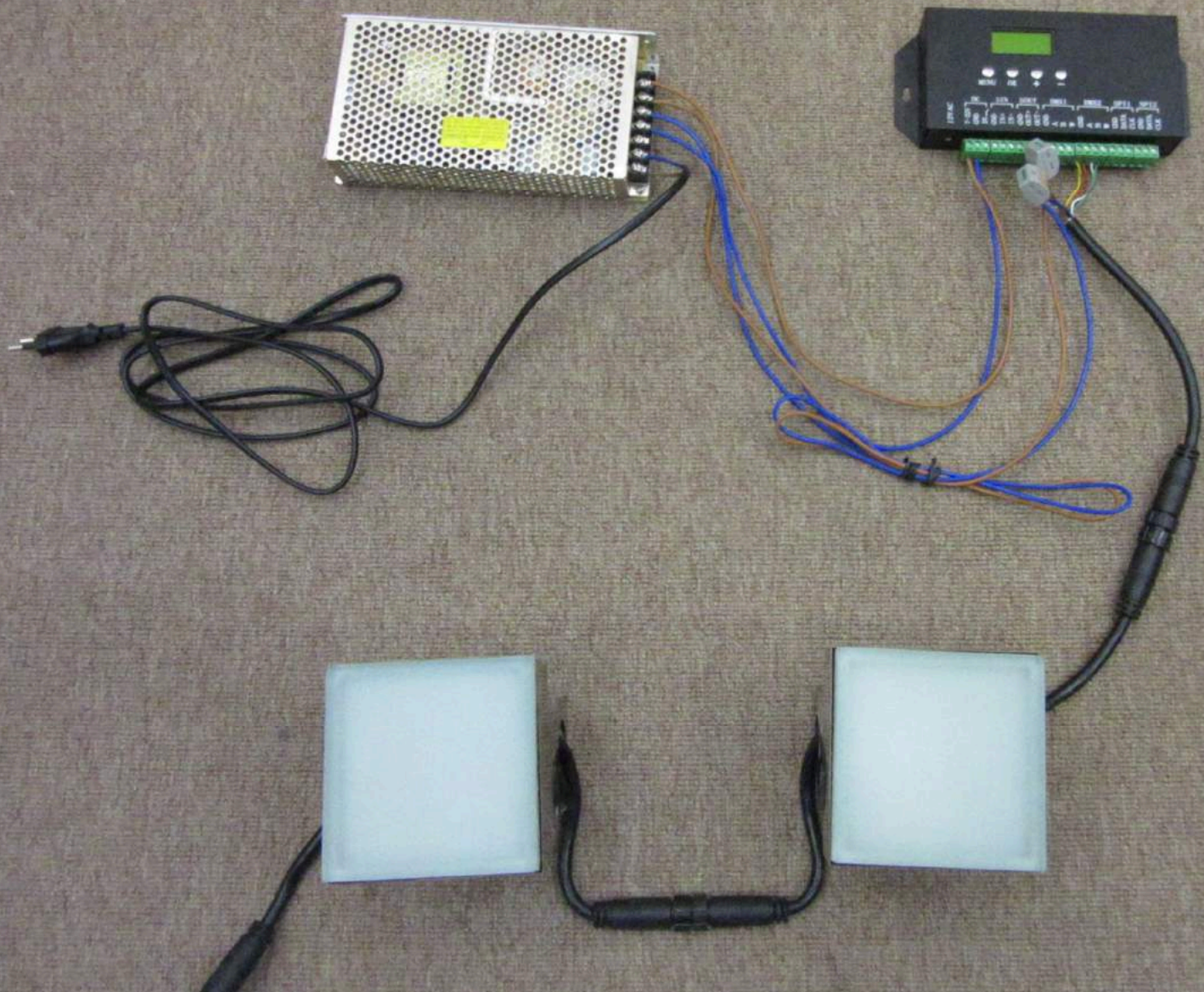

Step 9: Plug in 110-270VAC



110-270VAC

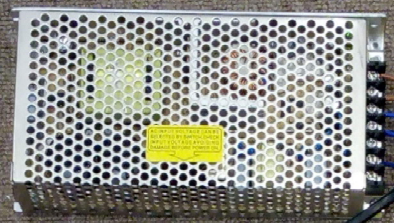

Light up!

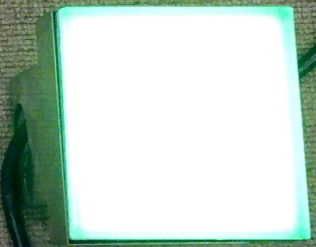



Step 10: Change light modes



MR-DMX05  
ST=001

Set up or choose different light modes

MENU OK + -

DC SIN SOUT DMX1 DMX2 SPI1 SPI2  
7-32V GND 5V GND IN+ IN- GND OUT+ OUT- GND A B W GND A B W GND DATA CLK GND DATA CLK





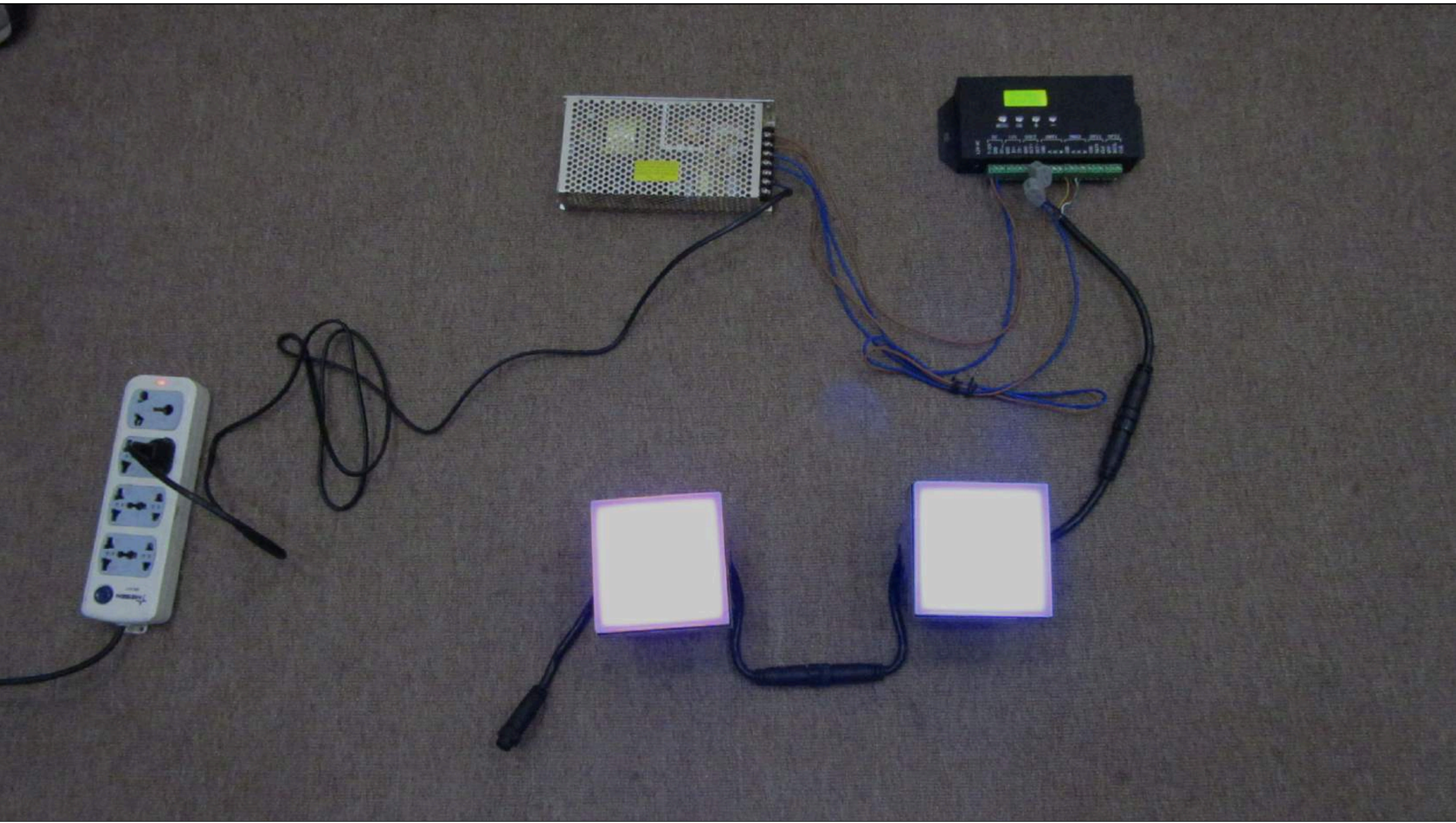

*Thank You for Watching!*

Contact: [sales23@shonelighting.com](mailto:sales23@shonelighting.com)