

# ABBA

LIGHTING USA

*12V Landscape Light Specialist*



# CDR30

## INSTALLATION GUIDE

[www.ABBALightingUSA.com](http://www.ABBALightingUSA.com)

## RATED VOLTAGE 12V AC/DC

Congratulations on your purchase of this high-quality product! We want to ensure that you have the best possible experience with it, so we kindly ask that you take a moment to carefully read and follow all instructions before assembly, installation, and use. By doing so, you'll not only guarantee correct function and safety, but also optimize the full potential of this exceptional product. Thank you for choosing us as your trusted provider of top-notch products - we truly appreciate your business!

### IMPORTANT SAFETY INSTRUCTIONS

#### LIGHTEN LAMP IS **HOT!**

#### **WARNING: TO REDUCE THE RISK OF FIRE OR INJURY TO PERSONS:**

- ✔ Please exercise caution when using the lamp, as it tends to **HEAT** up rapidly. We recommend taking necessary safety measures to ensure optimal usage.
- ✔ For your safety, please refrain from touching the **HOT** lens, guard, or enclosure. We recommend waiting for the product to cool down before handling it.
- ✔ To prevent any fire hazards, please ensure that the lamp is kept away from materials that may easily catch fire. We appreciate your cooperation in maintaining a safe and secure environment.
- ✔ For safety reasons, we recommend that only a qualified professional install this electrical product.
- ✔ Before attempting to install this unit, ensure all power connections are off for your own safety.

### WARRANTY

- We stand behind the quality of our product and offer a 2-year warranty from the date of purchase. Please note that the warranty is valid from the date of purchase, not from the date of installation. Kindly ensure that you keep the proof of purchase as it will be required for any warranty claims.
- Warranty will be void if there is any damage due to improper usage or modification to the fixture.
- Failure to comply with the instruction in this manual may increase the risk of damage or injury and will void warranty.



## CAUTION:

fixture(s) must be installed in accordance with all local codes and ordinances.  
Do not instal within 10 feet of a pool, spa or fountain

## INSTALLATION INSTRUCTION

To ensure optimal performance and safety, it is important to use our fixtures ONLY with a low voltage landscape transformer. This transformer reduces the voltage from 120V to 12V, making it safe and suitable for outdoor use.

When installing the fixture(s), please follow these instructions carefully:

1. Before installation, please ensure that the power is turned off for your safety.

2. To establish a dependable and enduring electrical connection between fixture wires and the main line in outdoor or underground installations, it is essential to select a suitable main cable connector designed for direct burial. This connector should be chosen based on its ability to withstand environmental conditions, resist moisture and corrosion, and provide robust insulation. By adhering to industry standards and best practices, including proper wire stripping and secure fastening techniques, a reliable connection can be established, ensuring optimal performance, safety, and longevity of the system.

We recommend using **WN12** waterproof wire nuts (sold separately) for optimal connectivity.

3. Strip the insulation: Carefully strip approximately 3/4 inch (1.9 cm) of insulation from the ends of the two wires you wish to connect. Ensure that the bare metal ends are clean and free from any frayed strands.

4. Align the wires: Hold the stripped ends of the two wires together, aligning them neatly and ensuring that no stray strands are crossing over.

5. Insert the aligned ends of the wires into the wire nut, ensuring that they go all the way in. The bare ends should be completely covered by the wire nut. Twist the wire nut: Firmly twist the wire nut clockwise onto the wires, ensuring a secure connection. Continue twisting until the wire nut is tight and snug. Test the connection: Gently tug on each wire to ensure they are securely held by the wire nut.

The connection should be firm and not come loose.

Inspect the connection: Examine the wire nut connection to ensure there are no exposed wires or loose strands. If any issues are detected, remove the wire nut and repeat the process from step 3.

Note: It's always recommended to follow local electrical codes and regulations when performing any electrical work. If you're uncertain or uncomfortable with electrical tasks, it's advisable to consult a qualified electrician. Safety should always be a top priority when working with electrical connections.

6. For a secure and stable mounting, dig a small hole and insert the spike into the ground, ensuring it is vertical and firm.

7. Adjust the light angle.

8. Turn on the power.

We strongly recommend that the main cable from the transformer be buried underground for safety reasons. Additionally, please be sure to avoid exceeding the maximum wattage on the fixture(s) to prevent any damage or hazards.



**By utilizing the remote control, you have the ability to modify the color according to your preferences**

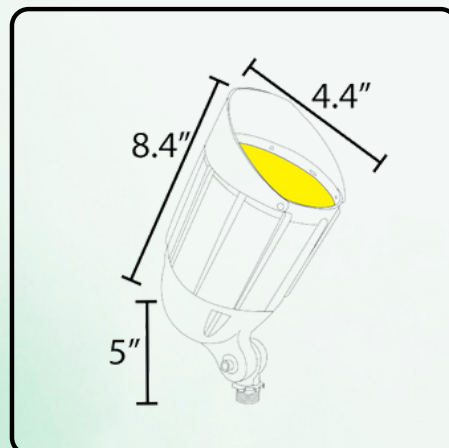
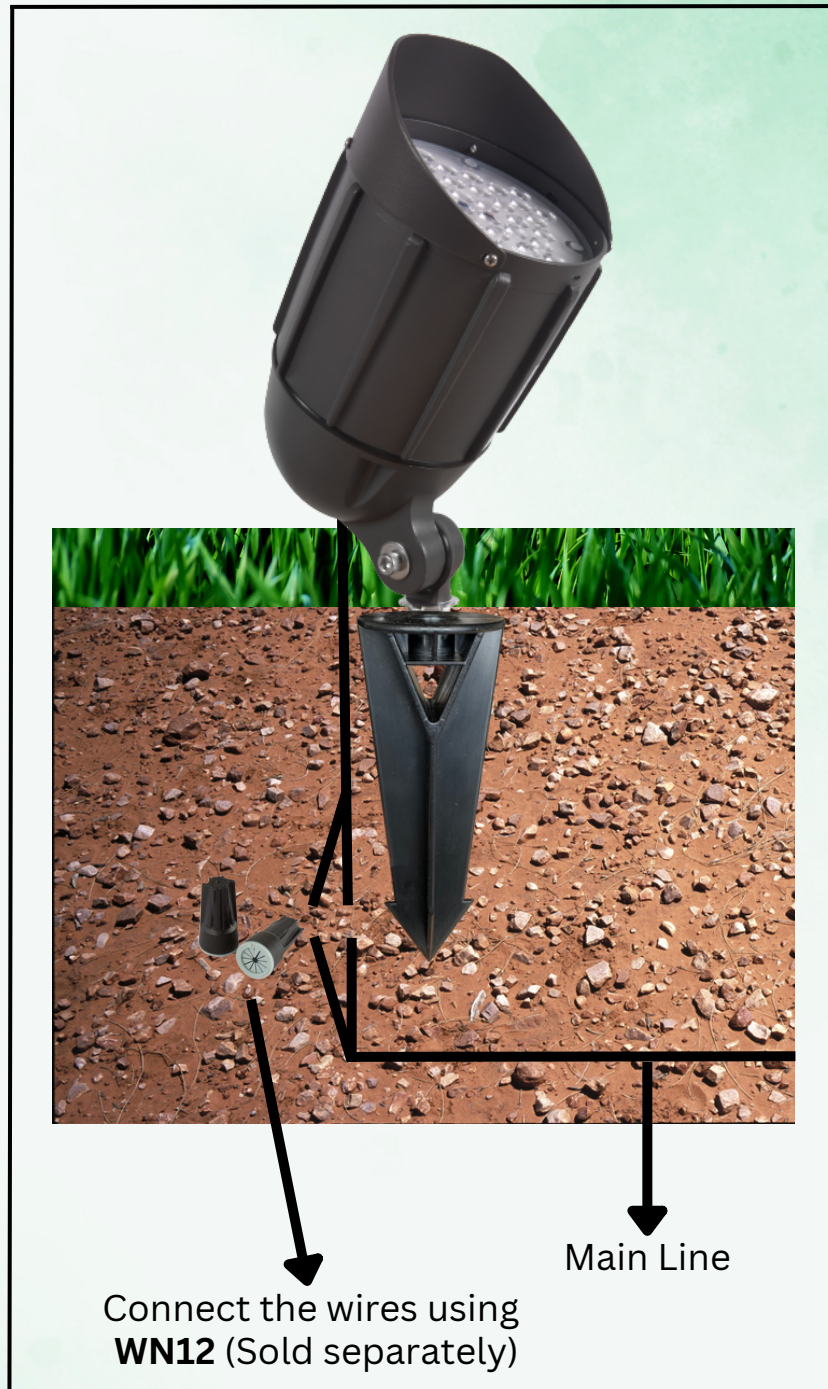



# APP CONNECTION AND MODES – LED BULLET FLOOD

1. Scan the QR code to download and install on your iOS device (iPhone, iPad) the application HappyLighting from the AppStore. on your Android device, download HappyLighting from Google Play Store.

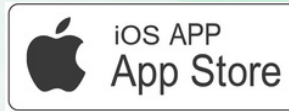

2. Turn on the Bluetooth on your Apple or Android device (see Fig. 1)

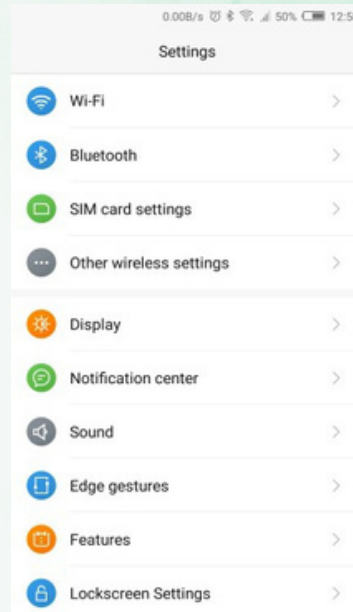

FIG.1

3. Turn on the bullet floodlights. Run the application and tap the button on the top left corner to show device list and select the light to start connection (Fig. 2).

4. You can group 3 to 12 lights using the app (It depends on which version of Android/iOS system you use), by tapping "Group Manage". Select the lights and add them to the desired group (Fig 3). Multiple groups can be created.

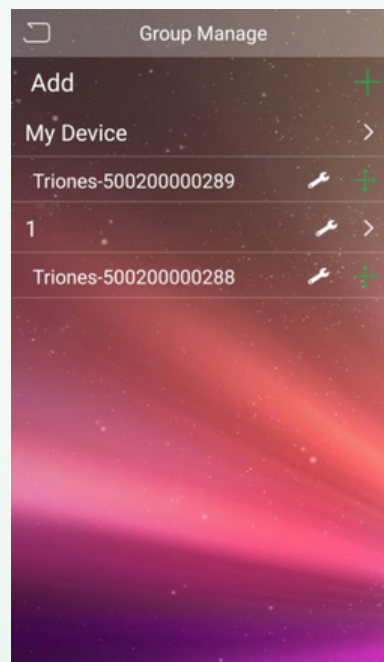
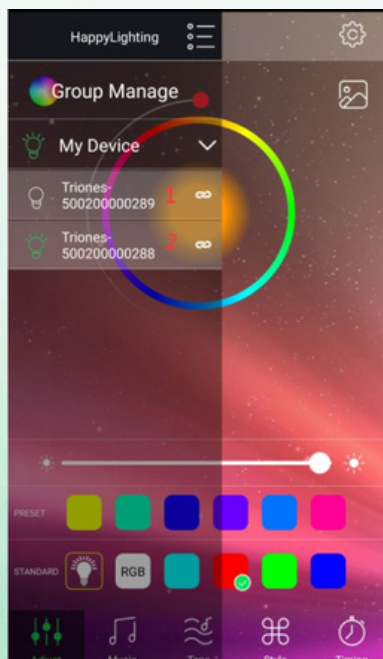

FIG.2 FIG.3

5. Music Mode - Tap the "Music" button to enter Music mode. In this mode the connected bullet floodlight will light in the rhythm of the music playing on the smartphone or tablet. To do this, select your music library on smartphone or tablet and select the desired music. With the pause/play button in the middle, you can start or stop the music and the LED light (Fig. 4).

6. Voice Mode - Tap the "Tape" button to enter in Voice mode. In this mode the connected bullet floodlight lights up depending on the volume / noise from the outside like a microphone (Fig. 5).

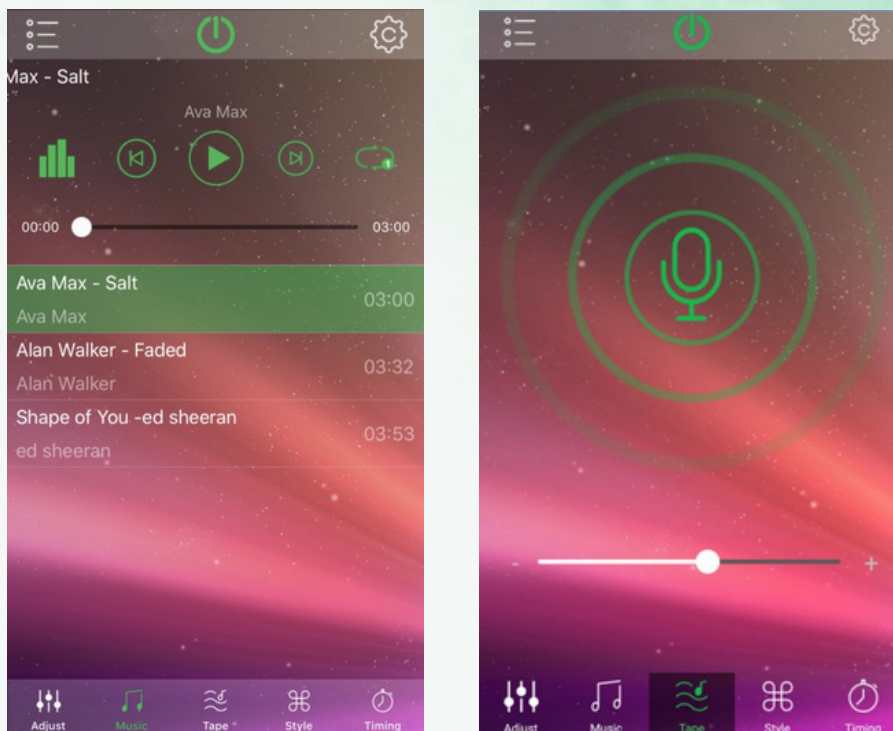

Fig. 4 Fig. 5

7. RGBW Mode - Tap the "Adjust" button to enter RGBW mode. You can adjust both the color RGB (Red/Green/Blue) as well as the brightness of the color. There are 6 preset and 6 standard color buttons for easy access to the individual channels. (Fig. 6)

8. RGB Scenes - Tap the "Style" button to enter RGB Scene mode. There are 20 preset modes. You can adjust the speed of each mode using the slider (Fig. 7).

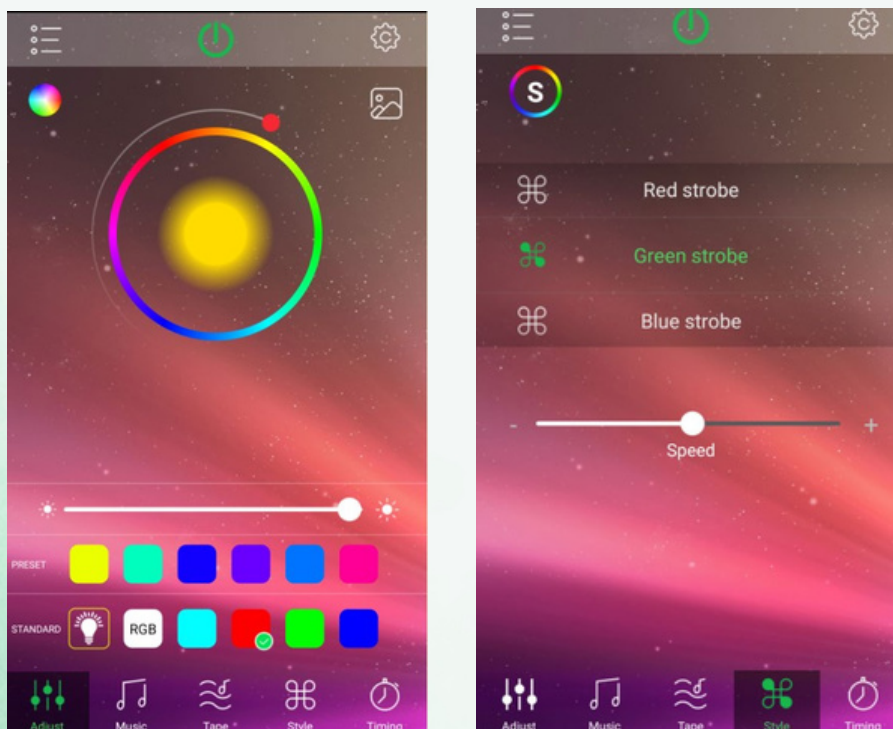

Fig.6 Fig.7



9.Timer - The controller has a built-in timer function. To access it tap the “Timing” button. You can set the desired ON or OFF time or you can set the light to work in a time interval. The timer will not operate if the power supply is interrupted (Fig. 8).

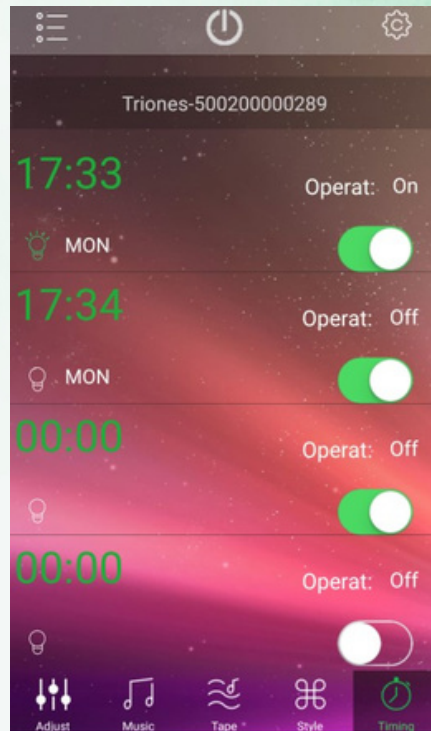

Fig.8

#### 10. Remote controller

ON/OFF Button - Switch the unit on or off.

Dimming and Speed - When in static monochrome mode use it to adjust the brightness; when the set mode is in FADE, STROBE, FLASH or SMOOTH it adjusts the speed

Static Monochrome - Use the buttons to directly select the desired color (16 choices)

FLASH - Automatic change of colors (fast)

STROBE - Automatic jumping change of colors (slow)

FADE - Automatic change of seven colors with blending effect

SMOOTH - Automatic change of three colors with blending effect

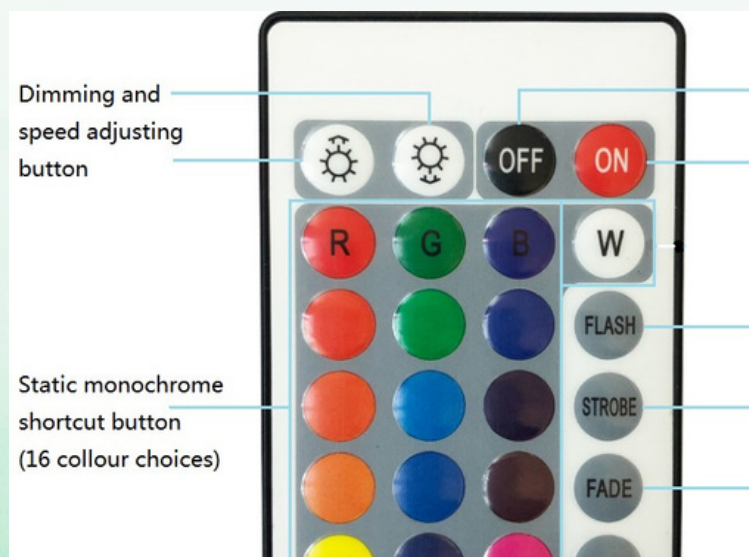

Fig.9